

ENVIRONMENTAL PRODUCT DECLARATION

THERMALLY IMPROVED ALUMINUM EXTRUSIONS

PAINTED AND ANODIZED



Aluminum Extrusions with a thermal barrier, either mill finished, painted, or anodized are primarily used for building and construction applications



By combining the outstanding characteristics of aluminum and the unique attributes of the extrusion process, aluminum extrusions offer engineers, architects, and product designers a unique combination of attributes that can lead to outstanding product solutions.

Strong, light weight, corrosion resistant, infinitely recyclable, available with a range of finishes and capable of complex shapes with tight tolerances and engineered performance, extrusions are ideally suited to today's world.

As the trade association for the North American aluminum extrusion industry, the Aluminum Extruders Council is committed to advancing extrusion technology, promoting the effective use of extrusions, advancing sustainability, and ensuring fair trade.

Visit www.aec.org for more information.



ENVIRONMENTAL PRODUCT DECLARATION



**ALUMINUM
EXTRUDERS
COUNCIL**

Aluminum Extrusions

Mill Finished, Painted, and Anodized

According to ISO 14025
and ISO 21930:2017

EPD PROGRAM AND PROGRAM OPERATOR NAME, ADDRESS, LOGO, AND WEBSITE	UL ENVIRONMENT 333 PFINGSTEN RD, NORTHBROOK, IL 60062	WWW.UL.COM WWW.SPOT.UL.COM
GENERAL PROGRAM INSTRUCTIONS AND VERSION NUMBER	Program Operator Rules v 2.7 2022	
ASSOCIATION NAME AND ADDRESS	Aluminum Extruders Council (AEC) 1000 N Old Rand Rd. Suite 214 Wauconda, IL 60084	
DECLARATION NUMBER	4790414446.101.1	
DECLARED PRODUCT & DECLARED UNIT	Thermally improved Aluminum extrusion products: Painted, and anodized; declared unit: 1 metric ton of aluminum extrusion products.	
REFERENCE PCR AND VERSION NUMBER	Product Category Rules for Building Related Products and Services, Part A: Life Cycle Assessment Calculation Rules and Report Requirements, V3.2 (UL, 2018); Part B: Aluminum Construction Product EPD Requirements, UL Standard 10010-38 , Edition 1 (UL, 2022).	
DESCRIPTION OF PRODUCT APPLICATION/USE	Thermally enhanced aluminum extrusions, including painted, and anodized used in construction.	
MARKETS OF APPLICABILITY	North America	
DATE OF ISSUE	November 1, 2022	
PERIOD OF VALIDITY	5 years	
EPD TYPE	Industry-average	
EPD SCOPE	Cradle to gate with required options, (modules A1-A3, modules C1-C4, and module D)	
YEAR(S) OF REPORTED PRIMARY DATA	2020-2021	
LCA SOFTWARE & VERSION NUMBER	GaBi v10	
LCI DATABASE(S) & VERSION NUMBER	GaBi 2021 (CUP 2021.2)	
LCIA METHODOLOGY & VERSION NUMBER	IPCC AR5 (GWP 100), TRACI 2.1 and CML-IA v4.8 (ADPf)	

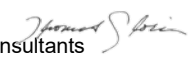
The sub-category PCR review was conducted by:	UL Environment
	PCR Review Panel
	epd@ul.com
This declaration was independently verified in accordance with ISO 14025: 2006. The UL Environment "Part A: Calculation Rules for the Life Cycle Assessment and Requirements on the Project Report," v3.2 (UL, 2018), in conformance with ISO 21930:2017, serves as the core PCR <input type="checkbox"/> INTERNAL <input checked="" type="checkbox"/> EXTERNAL	 Cooper McCollum, UL Environment
	ISO 21930:2017
The EPD conforms with:	
This life cycle assessment was independently verified in accordance with ISO 14044 and the reference PCR by:	Thomas P. Gloria, Industrial Ecology Consultants 

LIMITATIONS
The environmental impact results of aluminum products in this document are based on a declared unit and therefore do not provide sufficient information to establish comparisons. The results shall not be used for comparisons without knowledge of how the physical properties of the aluminum product impact the precise function at the construction level. The environmental impact results shall be converted to a functional unit basis before any comparison is attempted.

Environmental declarations from different programs (ISO 14025) may not be comparable.

ENVIRONMENTAL PRODUCT DECLARATION



Thermally Improved Aluminum Extrusions

Painted and Anodized

According to ISO 14025
and ISO 21930:2017

Product Definition and General Information

Description of Organization

The Aluminum Extruders Council (AEC), formed in 1949, is the trade association for the North American aluminum extrusion industry. With approximately 60 U.S. and Canadian extruder members (operating over 100 extrusion manufacturing locations), and a like number of aluminum producers and other industry suppliers, the Council represents an estimated 75% of North American aluminum extrusion production.

Today the Council focuses on four distinct missions:

Promoting the effective application of aluminum extrusions in North America to solve product challenges in a wide range of industries. Whether helping create more energy efficient buildings, improving automotive performance, facilitating the transition to LED lighting, or advancing products in a wide range of other industries, extrusions are playing a major role.

Advancing extrusion technology, sustainability, and competence, via member training, networking, benchmarking, best-practice sharing and research & development projects and conferences.

Ensuring fair trade.

Developing the human capital required for the coming years via apprentice programs, upskilling, and collaboration with educational institutions and workforce development programs

The Council brings comprehensive information about extrusion's characteristics, applications, environmental benefits, design and technology to users, product designers, engineers, and the academic community via an extensive set of resource materials, webinars and other educational programs. Further, the Council is focused on enhancing the ability of its members to meet the emerging demands of the market through sharing knowledge and best practices.

The information in this document is based on information supplied by 8 AEC member companies in the U.S. and Canada. The data comes from 31 separate production facilities, with a total of nearly 100 extrusion presses ranging in size from 6" to 18" circle size, 10 anodizing facilities, 10 paint facilities (liquid and powder), 6 thermal management operations, and 13 cast houses that produce scrap-based extrusion billets. Total extrusion production by the AEC participants is 2.46 billion lbs. which is 38% of the total Aluminum extrusions in North America for the 2020 production year (AA, 2022).

Participating companies



ENVIRONMENTAL PRODUCT DECLARATION



ALUMINUM
EXTRUDERS
COUNCIL

Thermally Improved Aluminum Extrusions

Painted and Anodized

According to ISO 14025
and ISO 21930:2017

Product Description

This EPD covers the production of thermally enhanced aluminum extrusions, including mill finished, painted (liquid and powder paint), and anodized. It excludes downstream fabrication operations such as tight tolerance cutting, machining, punching, bending, welding and assembly due to the wide diversity of such operations. The results are production-weighted averages that are representative of all extruded aluminum products produced in the U.S. and Canada. The Table -1 represents the product description. Table -1 represents the product description.

While thermally improved mill finish extrusion may also be produced and sold, the incidence of this configuration is so low it precludes meaningful data, hence the Mill-finish thermally treated Aluminum extrusions are excluded from this EPD.

Table 1. Product description

Name	Value
Product Name	Thermally enhanced aluminum extrusions, including painted (liquid and powder paint), and anodized.
Product Description	Basic aluminum extrusions, including painted (liquid and powder paint), and anodized, that have been thermally enhanced. This EPD excludes downstream fabrication operations such as tight tolerance cutting, machining, and assembly due to the wide diversity of such operations.
Classification	Semi-fabricated construction product
Classification (Semi-Fabricated Products Only)	Raw materials: Aluminum billet Output: Thermally enhanced aluminum extrusions
Finishing	Painting and anodizing
Alloy Group	6000 series alloy (6xxx alloy)

Application

Aluminum extrusions are utilized in a wide variety of market sectors, including:

- **Building and construction:** windows, doors, curtain walls, façade systems, skylights, canopies, louvers, light shelves, interior partitions, bridges, etc.
- **Transportation:** automotive structural and chassis components, crash management systems, auto body and trim components, BEV battery enclosures, truck and trailer components, rail passenger and freight car components, etc.
- **Electrical and energy:** electronics housings and heat sinks, LED lighting components, solar energy mounting and racking systems, cable raceways, conduit, etc.
- **Medical and consumer durables:** components of recreation products, home & garden tools, appliances, ambulatory care products, medical diagnostic equipment, etc.

Industry Standards

AAMA 611-20: Voluntary Specification for Anodized Architectural Aluminum

AAMA 612-20: Voluntary Specification, Performance Requirements, and Test Procedures for Combined Coatings of Anodic Oxide and Transparent Organic Coatings on Architectural Aluminum

ENVIRONMENTAL PRODUCT DECLARATION



ALUMINUM
EXTRUDERS
COUNCIL

Thermally Improved Aluminum Extrusions

Painted and Anodized

According to ISO 14025
and ISO 21930:2017

AAMA 2603-21: Voluntary Specification, Performance Requirements and Test Procedures for Pigmented Organic Coatings on Aluminum Extrusions and Panels

AAMA 2604-21: Voluntary Specification, Performance Requirements and Test Procedures for High Performance Organic Coatings on Aluminum Extrusions and Panels

AAMA 2605-20: Voluntary Specification, Performance Requirements and Test Procedures for Superior Performing Organic Coatings on Aluminum Extrusions and Panels

ASTM B221-21, B221M-21 Standard Specifications for Aluminum and Aluminum-Alloy Extruded Bars, Rods, Wire, Profiles, and Tubes

ASTM B429/B429M-20 Standard Specification for Aluminum-Alloy Extruded Structural Pipe and Tube

ASTM B491/B491M-15 Standard Specification for Aluminum and Aluminum-Alloy Extruded Round Tubes for General purpose applications

Declaration Of Methodological Framework

This EPD is declared under “cradle to gate with options” system boundary. As such, it includes life cycle stages A1-A3, C1-C4 and D.

Delivery Status

The output of the extrusion process is a semi-fabricated and surface finished extrusion product, ready for additional fabrication or transportation to a component or final product manufacturer. Most North American extrusions are custom designs for specific end-use applications; they do not have standard dimensions as configuration and dimensions are specified by the consumer.

Technical Properties of The Product as Delivered

Technical data (Table 2) is representative of 6xxx series alloy (tempers T1 – T6), the predominant alloy produced by the participants.

Table 2. Technical data

Name	Value	Unit
Density	2.66 – 2.84	(kg/m ³) x 10 ³
Melting point (typical)	475 – 655	°C
Electrical conductivity (typical) at 20°C / 68°F	Equal volume: 16 – 36	Ms/m (0.58 x %IACS)
Thermal conductivity (typical) at 25°C / 77°F	170 – 210	W/m·K
Average coefficient of thermal expansion (typical) 20°C to 100°C / 68°F to 212°F	22.3 – 23.9	per °C
Modulus of elasticity (typical)	69 – 73	MPa x 10 ³
Hardness (typical)	40 – 95 (47 – 96)	HB (Rockwell E)
Yield strength (min)	60 – 330	MPa
Ultimate tensile strength (min)	120 – 370	MPa
Breaking elongation (min) (50mm & 4D)	>4	%

ENVIRONMENTAL PRODUCT DECLARATION



**ALUMINUM
EXTRUDERS
COUNCIL**

Thermally Improved Aluminum Extrusions

Painted and Anodized

According to ISO 14025
and ISO 21930:2017

Chemical composition	Varying by alloy, Al 95.2 – 98.6	% by mass
Density	2.66 – 2.84	(kg/m ³) x 10 ³
Melting point (typical)	475 – 655	°C

Table 3. 6063 aluminum alloy chemical composition (% by mass) as per Teal Sheet (AA, 2018)

	Si	Fe	Cu	Mn	Mg	Cr	Zn	Ti	Others (total)	Aluminum
Minimum	0.20		--	--	0.45					remainder
Maximum	0.60	0.35	0.10	0.10	0.90	0.10	0.10	0.10	0.15	remainder

Material Composition: Base and Ancillary Materials

Extruded aluminum products produced in North America typically contain a considerable proportion of metal recycled from aluminum scrap. The average metal composition of North American products, based on metal feedstock information collected from the companies participating in this EPD, is as follows:

Table 4. Metal Composition

Category of Metal Source	Percentage (by mass)
Primary Metal (including alloying agents)	47 %
Recovered Aluminum content	53 %

The composition in the cast house aluminum ingots can be broken down into post-consumer and postindustrial scrap based on the available data. Some cast house facilities had an input of secondary ingot, which had been categorized as post-consumer scrap for this calculation.

Table 5. Metal Composition for cast house ingots

Category of Metal Source	Percentage (by mass)
Primary Metal (including alloying agents)	30.3 %
Recovered Aluminum from Post-Industrial (Pre-Consumer) Scrap	50.5 %
Recovered Aluminum from Post-Consumer Scrap	19.2 %

The definitions for post-industrial and post-consumer aluminum scrap are consistent with ISO 14021/25 and the related interpretations by UL Environment. Post-industrial scrap typically includes extrusion drop-offs from cutting, off-spec material, and scrap generated during subsequent processing by extruders or customers. Post-consumer scrap is scrap that has been used for an intended application as part of a previous product life cycle. It often includes aluminum wheels, wire, and reclaimed material from building demolition/renovation or auto dismantling.

Extruded aluminum products produced for different customers, applications, and market sectors may vary substantially in metal composition, ranging from 100% primary aluminum to nearly 100% aluminum scrap. There is no relevant chemical composition difference between primary and scrap-based product if both are governed by the same alloy designation and chemical composition limit standards.

ENVIRONMENTAL PRODUCT DECLARATION



ALUMINUM
EXTRUDERS
COUNCIL

Thermally Improved Aluminum Extrusions

Painted and Anodized

According to ISO 14025
and ISO 21930:2017

Manufacturing

Extrusion

The production stage starts with extraction and processing of aluminum ingot, billet, and ancillary materials, followed by the transportation of these materials to the plant.

The extrusion manufacturing process, as shown in Figure -1 takes cast extrusion billet (round bar stock, produced from direct chill molds and typically ranging in diameter from 6 to 14 inches) and produces extruded profiles. The process begins with an inline preheat furnace that elevates the temperature of the billet to a predetermined level, around 900 °F depending on the alloy. If not already cut to length, the billet is then sheared and placed into a hydraulic press, which then forces the semi-plastic billet through a heated steel die to form the desired shape. The length of the resulting extrusion is dictated by the take-off tables. The extrusions are air cooled or water quenched, with specific quench parameters dependent on alloy and desired microstructure and properties. The extrusion is then clamped and stretched to straighten the profile. Subsequently, the stretched profile is cut to length and then aged for several hours at elevated temperature (e.g. 350 °F) to achieve desired properties.

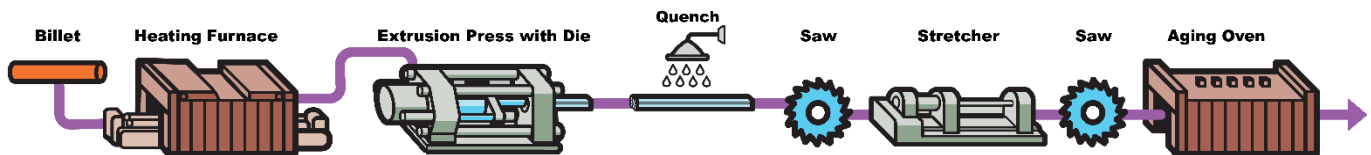

Figure 1. Extrusion manufacturing process schematic

Painting

Extrusions to be painted are typically cleaned and then treated with a pre-coat in either a vertical or horizontal paint booth. Depending on the ultimate paint performance desired, a variety of pre-coats and primers may be employed. After pre-treatment, the extrusions will be coated with a liquid or powder paint and baked. Various paint formulations may be used depending on the desired performance.

Anodization

If extrusions are to be anodized, they are cleaned and etched (with either caustic or acid etch) in a series of baths. Subsequently, they are immersed in an acid electrolyte bath and an electrical current is passed through the solution. A cathode is mounted to the inside of the anodizing tank, while the aluminum extrusions act as an anode. Oxygen ions are released from the electrolyte and combine with aluminum atoms at the surface of the extrusion being anodized, thereby creating a durable aluminum oxide layer fully integrated with the underlying aluminum. Organic or inorganic colorants can subsequently be added. The final step is a sealing stage to enhance durability.

Thermal improvement

Two alternative thermal barrier processes are typically used:

- A "pour & debridge" system in which a polyurethane liquid is allowed to harden in a "pocket" designed into the extrusion. The aluminum forming the pocket is then removed to allow the hardened polyurethane to act as an insulator.

ENVIRONMENTAL PRODUCT DECLARATION



ALUMINUM
EXTRUDERS
COUNCIL

Thermally Improved Aluminum Extrusions

Painted and Anodized

According to ISO 14025
and ISO 21930:2017

- A polyamide strip system where a rigid polyamide strip is mechanically crimped between two extrusions designed to accept the strip—thus creating the insulator.

Basic pour & debridge and polyamide strip systems are shown below. Note that advanced approaches with multiple voids and/or insulating materials can be used for high levels of thermal performance.

Pour & Debridge: Creation of a thermal barrier using pour & debridge is a 3-step process:

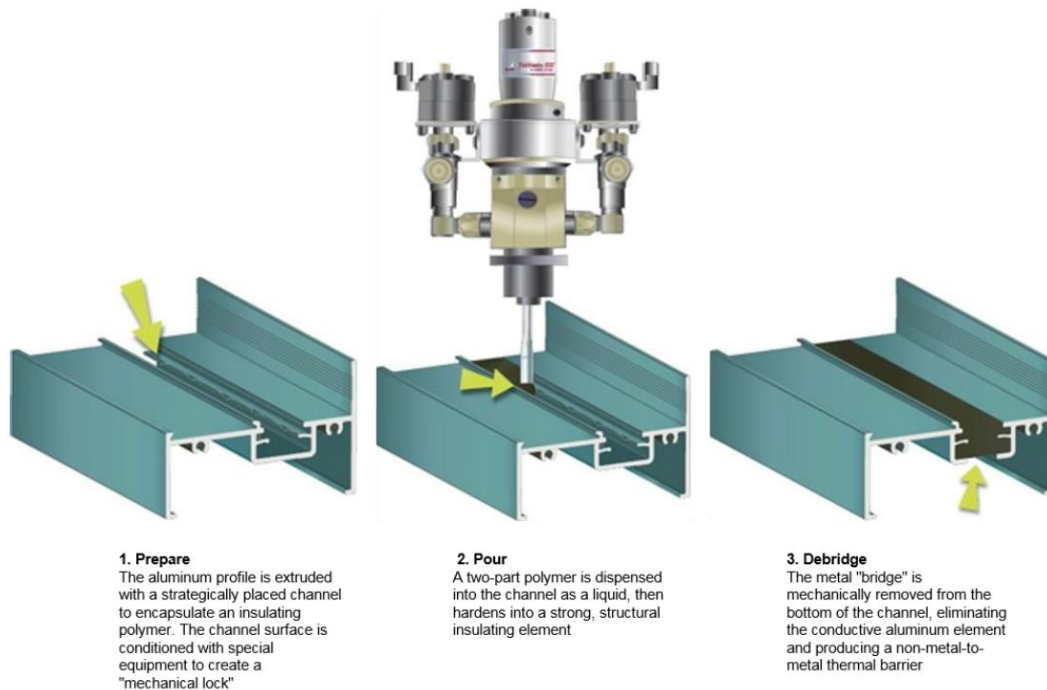

Figure 2. Pour and debridge process

Polyamide Strip: Creating a thermal break using a polyamide strip system involves 3 steps. (Note: Strips are available with a variety of configurations, to meet differing performance requirements).

ENVIRONMENTAL PRODUCT DECLARATION



ALUMINUM
EXTRUDERS
COUNCIL

Thermally Improved Aluminum Extrusions

Painted and Anodized

According to ISO 14025
and ISO 21930:2017



1. Profile knurling

A knurling wheel is used to produce "teeth" between 0.15 mm and 0.30 mm long in a pocket of the inner and outer extruded profiles that will be joined by the Strip to comprise the frame. These "teeth" will bite into the Strip during the crimping process and insure adequate shear strength for the composite profile.

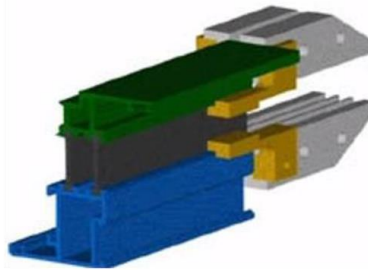

2. Strip insertion

Typically, the Polyamide Strip is pulled or pushed into the extrusion profile, using specialized equipment. However, manual insertion can also be used, and there are assembly methods that pull or push the profile onto the Strip. The preferred method is up to the installer.

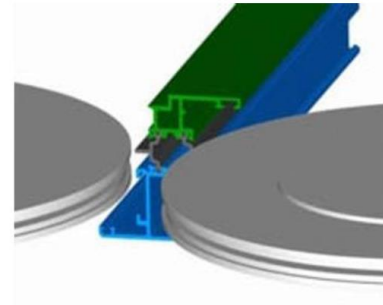

3. Crimping

Three sets of wheels rotate the extrusion onto the Strip and mechanically lock the components together. Over 1300 pounds of pressure is applied in stages, and the resulting aluminum/Strip assembly will then act as a load-bearing composite. Shear testing is typically conducted periodically to verify that the process has produced an assembly that will perform structurally as required.

Figure 3. Polyamide strip process

The manufacturing process is illustrated in the diagram below.

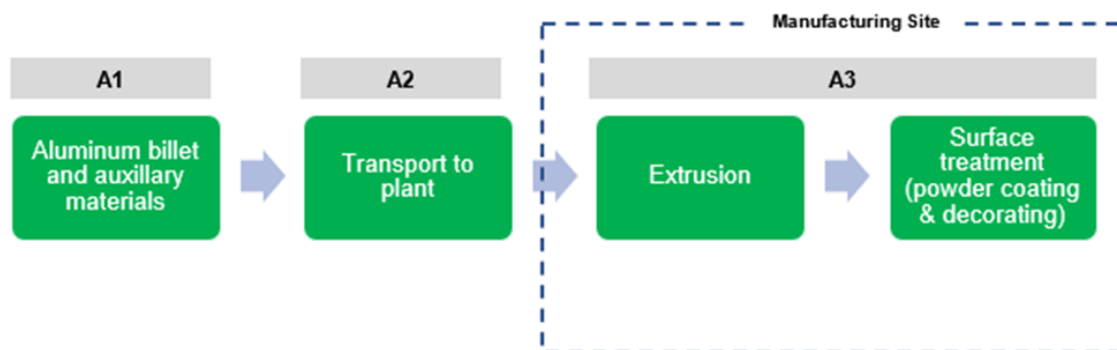

Figure 4. Breakdown of life cycle stages for aluminum extrusion

Manufacturing locations

The members who participated in this study produce aluminum extrusions across the United States and Canada, as shown in Figure 5.

ENVIRONMENTAL PRODUCT DECLARATION



ALUMINUM
EXTRUDERS
COUNCIL

Thermally Improved Aluminum Extrusions

Painted and Anodized

According to ISO 14025
and ISO 21930:2017

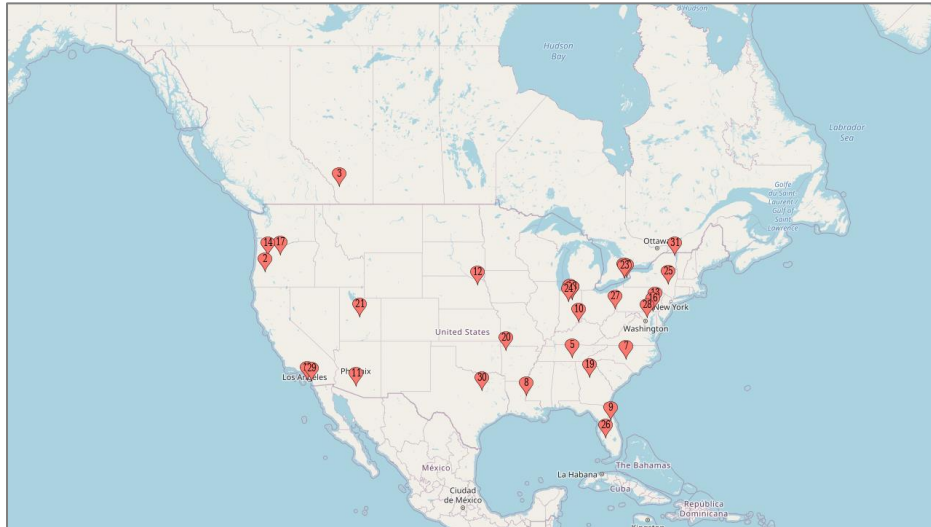

Figure 5 Map indicating locations of companies that participated in the study

Packaging

It was not always possible to distinguish intermediate flows between extrusion and the finishing steps. One example of this is packaging. To avoid double counting of packaging impacts, total packaging for all products was aggregated into the extrusion process.

Wood, plastic, and cardboard packaging, as well as returnable bins or pallets are considered in this study.

Transportation

Transportation to the customer or construction site s outside the scope of this EPD.

Product Processing/Installation

Installation is outside of the scope of this EPD.

Use

Outside of the scope of this EPD.

Reference Service Life

Service lives for aluminum extrusions will vary depending on the application but are typically on the order of decades due to aluminum's high corrosion resistance. This EPD does not cover the product use stage and therefore makes no specific claims regarding typical service lives.

Recycling And Disposal

Aluminum extrusions are a highly efficient, sustainable building material. Aluminum is 100% recyclable and can be recycled repeatedly. Recycled aluminum can be identical to smelted aluminum but requires a fraction of energy to manufacture. In

ENVIRONMENTAL PRODUCT DECLARATION



ALUMINUM
EXTRUDERS
COUNCIL

Thermally Improved Aluminum Extrusions

Painted and Anodized

According to ISO 14025
and ISO 21930:2017

building and construction, aluminum scrap has a recycling rate of 95% (UNEP, 2011) (AA, 2022). The remaining 5% is sent to landfill.

Table 6. Recycling and disposal

Name	Value
Deconstruction	--
Transportation to the disposal site	100 km by truck
Waste processing	--
Disposal to landfill	5%
Recycling rate of the product	95%
Removals of biogenic carbon	N/A

Environment And Health

Product manufacturing: Plant emissions to air/soil/water are monitored (if applicable) and comply with local laws.

Product use: Extrusion products are not expected to create exposure conditions that exceed safe thresholds for health impacts to humans or flora/fauna under normal operating conditions. Aluminum extrusions, whether mill finish, painted or anodized are free of "red list" ingredients (White Paper-AEC, 2022).

Extraordinary Effects

Fire: Aluminum extrusions comply with all local and federal laws with respect to fire hazards and control. Aluminum extrusions are noncombustible per ASTM E136.

Water: There is no evidence to suggest water runoff or exposure under normal and intended operation will violate general water quality standards.

Mechanical destruction: Not relevant for aluminum extrusions

ENVIRONMENTAL PRODUCT DECLARATION



ALUMINUM
EXTRUDERS
COUNCIL

Thermally Improved Aluminum Extrusions

Painted and Anodized

According to ISO 14025
and ISO 21930:2017

Life Cycle Assessment Background Information

Declared Unit

The declared unit for this EPD is one (1) metric ton (1,000 kg) of aluminum extrusion products, with thermal treatment along with surface treatments; painting and anodization.

Table 7. Declared unit

Name	Value	Unit
Declared unit	1	metric ton
Density (typical)	2700	kg/m ³

System Boundary

Per the PCR, this “cradle-to-gate with options” analysis provides information on the Product Stage of the aluminum product life cycle (comprising modules A1–A3), the End-of-Life Stage (modules C1-C4), and module D, which reports on the potential benefits or burdens associated with recycling and recovery at end-of-life.

- A1: Raw material supply – Recovery or extraction of feedstock materials, furnace and melt shop operations, and casting.
- A2: Transport – Transport to manufacturing site.
- A3: Manufacturing – Finishing (hot rolling, cold rolling, extrusion, forging, and casting), and final processing (anodizing, coating, surface treatment, etc.)
- C1: Deconstruction – Demolition processes.
- C2: Transport – Transport to waste processing.
- C3: Waste processing – Waste collection and processing.
- C4: Disposal – Waste disposal, treatment, and management at the end of the life cycle.
- D: Reuse, recovery, recycling potential - Net benefits resulting from reuse, energy recovery and recycling.

Table 8 represents the system boundary and scope.

ENVIRONMENTAL PRODUCT DECLARATION



**ALUMINUM
EXTRUDERS
COUNCIL**

Thermally Improved Aluminum Extrusions

Painted and Anodized

According to ISO 14025
and ISO 21930:2017

Table 8. System boundary modules included and excluded from the study

DESCRIPTION OF THE SYSTEM BOUNDARY (X = INCLUDED IN LCA; MND = MODULE NOT DECLARED)																
PRODUCT STAGE			CONSTRUCTION PROCESS STAGE		USE STAGE							END OF LIFE STAGE				BENEFITS AND LOADS BEYOND THE SYSTEM BOUNDARIES
Raw material supply	Transport	Manufacturing	Transport	Construction-installation process	Use	Maintenance	Repair	Replacement ¹	Refurbishment ¹	Operational energy use	Operational water use	De-construction demolition	Transport	Waste processing	Disposal	Reuse-Recovery-Recycling-potential
A1	A2	A3	A4	A5	B1	B2	B3	B4	B5	B6	B7	C1	C2	C3	C4	D
X	X	X	MND	MND	MND	MND	MND	MND	MND	MND	MND	X	X	X	X	X

X = module included, MND = module not declared

It should be noted here that, C1 and C3 are reported as zero as they are assumed to fall below the cut-off criteria defined by ISO 21930. C2 is assumed as 100 km by truck. Materials for recycling (95%) for aluminum is reported in module C1.

Time coverage: AEC’s primary data represent production between calendar years 2020 and 2021. Background data for upstream and downstream processes (i.e., raw materials, energy resources, transportation, and ancillary materials) were obtained from the GaBi 10 (CUP 2021.2) databases.

Technology coverage: Data were collected for the production of thermally improved painted and anodized aluminum extrusions for the participating facilities.

Geographical coverage: The geographical coverage for this study is based on North American system boundaries for all processes and products. Whenever Canadian or U.S. background data were not readily available, European data or global data were used as proxies.

Estimates And Assumptions

All the raw materials and energy inputs have been modeled using processes and flows that closely follow actual production data on raw materials and processes. All reported material and energy flows have been accounted for. No known flows are deliberately excluded from this EPD.

Cut-off-Rules

In the case of data gaps for unit processes, the cut-off criteria as defined by ISO 21930 were applied. All available energy and material flow data have been included in the model. In cases where no matching life cycle inventories are available to represent a flow, proxy data have been applied based on conservative assumptions regarding environmental impacts.

ENVIRONMENTAL PRODUCT DECLARATION



ALUMINUM
EXTRUDERS
COUNCIL

Thermally Improved Aluminum Extrusions

Painted and Anodized

According to ISO 14025
and ISO 21930:2017

Data Sources

The LCA model was created using the GaBi 10 software system for life cycle engineering, developed by Sphera (Sphera, 2021). Background life cycle inventory data for raw materials and processes were obtained from the GaBi 2021 database (CUP 2021.2).

Industry average Aluminum Association (AA) dataset for primary Aluminum ingot is used to represent all primary aluminum in this study. Table 9. represents the carbon intensity and share of electricity for AA dataset. The carbon intensity values are adapted from GaBi database (Sphera, 2021).

Table 9. Data sources, origin, and carbon intensity for primary aluminum (AA, 2022)

Dataset used in the calculation	Geographic origin	Carbon intensity per 1 kg (kgCO ₂ eq/kwh)	Power mix for Smelting for North American Primary Aluminum	Share of power in the mix	kwh / kg with share
Primary aluminum ingot (AA)	North America	0.015	Hydro	79.99%	9.60E+00
		1.100	Coal	16.91%	4.43E-01
		0.981	Oil	0.01%	4.16E-08
		0.546	Natural Gas	2.69%	1.13E-02
		0.005	Nuclear	0.40%	2.51E-04

Data Quality

A variety of tests and checks were performed by the LCA practitioner throughout the project to ensure high quality of the completed LCA. Checks included an extensive internal review of the industry wide LCA models developed as well as the background data used. A full data quality assessment is documented in the background report.

Period Under Review

Primary data were collected for mill-finished, painted, and anodized aluminum extrusions production during the year 2020. Background data for upstream and downstream processes (i.e., raw materials, energy resources, transportation, and ancillary materials) were obtained from the GaBi 2021 databases.

Allocation

No multi-output (i.e., co-product) allocation was performed in the foreground system of this study.

Allocation of background data (energy and materials) taken from the GaBi 2021 databases is documented online at <https://sphera.com/wp-content/uploads/2020/04/Modeling-Principles-GaBi-Databases-2021.pdf>. Also please refer to the 2022 LCA report on semi-fabricated aluminum. for more information : https://www.aluminum.org/sites/default/files/2022-01/2022_Semi-Fab_LCA_Report.pdf

Per the PCR guidance, recycling and recycled content in the cradle-to-gate system are modeled using the cut-off rule (a.k.a, the recycled content rule). All materials that are recycled from unit processes are considered to have left the system boundary. Recycled content is modeled in the system only when the percent of recycled content was specified in the material purchase.

ENVIRONMENTAL PRODUCT DECLARATION



ALUMINUM
EXTRUDERS
COUNCIL

Thermally Improved Aluminum Extrusions

Painted and Anodized

According to ISO 14025
and ISO 21930:2017

Interpreting The Results in Module D

The values in Module D include a recognition of the benefits or impacts related to aluminum recycling which occur at the end of the product’s service life. The rate of aluminum recycling and related processes will evolve over time. The results included in Module D attempt to capture future benefits, or impacts, but are based on a methodology that uses current industry-average data reflecting current processes.

A net scrap approach was taken to capture the benefits related to aluminum recycling reported in module D. The following datasets in

Table 10. were used to calculate the associated aluminum credit:

Table 10. Background datasets used for module D

Background datasets (Sphera, 2021)	Reference year
RNA: Secondary aluminum ingot (95% recycled content) AA	2016
RNA: Primary aluminum ingot AA	2016

The net scrap approach is based on the perspective that material that is recycled into secondary material at end-of-life will replace for an equivalent amount of virgin material. Hence a credit is given to account for this material substitution. However, this also means that burdens equivalent to this credit should be assigned to scrap used as an input to the production process, with the overall result that the impact of recycled granulate is the same as the impact of virgin material. This approach rewards end of life recycling but does not reward the use of recycled content. A schematic of the Module D calculation is presented in Figure 1 to further explain the net scrap approach that is considered in aluminum end-of-life recycling.

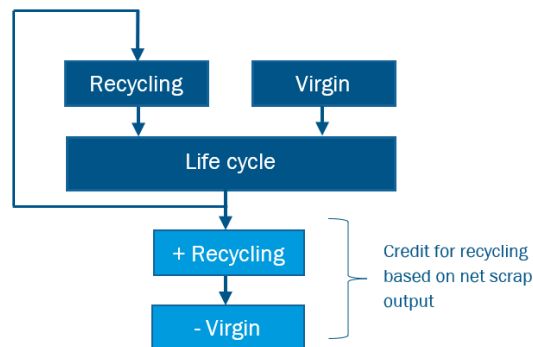

Figure 6. Schematic for the net-scrap approach (credit given at the end-of-life)

ENVIRONMENTAL PRODUCT DECLARATION



ALUMINUM
EXTRUDERS
COUNCIL

Thermally Improved Aluminum Extrusions

Painted and Anodized

According to ISO 14025
and ISO 21930:2017

Life Cycle Assessment Results

North American life cycle impact assessment (LCIA) results are declared using TRACI 2.1 (Bare, 2012; EPA, 2012) methodology, with the exception of GWP which is reported using the IPCC AR5 (IPCC, 2013) methodology, excluding biogenic carbon and ADP fossil which is reported using CML-IA v4.8 (CML, 2016). Primary energy use represents the lower heating value (LHV) a.k.a. net calorific value (NCV).

LCIA results are relative expressions and do not predict actual impacts, the exceeding of thresholds, safety margins or risks.

No company participated in providing data for mill-finish thermally treated aluminum extrusions. Therefore, the results are only presented for anodized and painted thermally treated aluminum extrusion products.

Table 11. Life cycle impact assessment results per metric ton of thermally treated ANODIZED aluminum extrusion products

Impact Category	Unit	A1	A2	A3	C1	C2	C4	D
LIFE CYCLE IMPACTS ASSESSMENT (LCIA) RESULTS								
<i>IPCC, AR5 (IPCC, 2013)</i>								
Global warming potential (GWP 100)	kg CO ₂ eq.	8.28E+03	2.65E+01	3.49E+03	–	1.02E+01	2.20E+00	-8.61E+03
<i>TRACI v2.1 and CML-IA v4.8</i>								
Ozone depletion potential (ODP)	kg CFC 11 eq.	3.76E-07	5.42E-15	6.77E-07	–	2.13E-15	7.35E-15	-2.88E-12
Acidification potential (AP)	kg SO ₂ eq.	3.53E+01	1.18E-01	4.66E+00	–	1.97E-02	9.37E-03	-4.03E+01
Eutrophication potential (EP)	kg N eq.	1.03E+00	1.07E-02	3.53E-01	–	2.83E-03	5.22E-04	-8.94E-01
Smog formation potential (SFP)	kg O ₃ eq.	3.09E+02	2.91E+00	8.44E+01	–	4.46E-01	1.66E-01	-3.31E+02
Abiotic resource depletion potential of non-renewable (fossil) energy resources (ADP _{fossil})	MJ	8.27E+04	3.83E+02	4.65E+04	–	1.50E+02	3.29E+01	-7.74E+04
RESOURCE USE INDICATORS								
Renewable primary resources used as energy carrier (fuel) (RPR _E)	MJ	4.79E+04	1.55E+01	6.01E+03	–	6.23E+00	2.80E+00	-5.60E+04
Renewable primary resources with energy content used as material (RPR _M)	MJ	0.00E+00	0.00E+00	3.36E-05	–	0.00E+00	0.00E+00	0.00E+00
Non-renewable primary resources used as an energy carrier (fuel) (NRPR _E)	MJ	8.10E+04	3.86E+02	5.44E+04	–	1.51E+02	3.36E+01	-7.88E+04
Non-renewable primary resources with energy content used as material (NRPR _M)	MJ	3.57E+03	0.00E+00	6.68E+02	–	0.00E+00	0.00E+00	0.00E+00
Renewable secondary fuels (RSF)	MJ	0.00E+00	0.00E+00	0.00E+00	–	0.00E+00	0.00E+00	0.00E+00
Non-renewable secondary fuels (NRSF)	MJ	0.00E+00	0.00E+00	0.00E+00	–	0.00E+00	0.00E+00	0.00E+00
Recovered energy (RE)	MJ	–	–	–	–	–	–	–
Secondary materials (SM)	kg	9.57E+02	0.00E+00	0.00E+00	–	0.00E+00	0.00E+00	0.00E+00
Use of net fresh water resources (FW)	m ³	1.59E+02	6.63E-02	4.41E+01	–	2.66E-02	4.62E-03	-1.85E+02

ENVIRONMENTAL PRODUCT DECLARATION



ALUMINUM
EXTRUDERS
COUNCIL

Thermally Improved Aluminum Extrusions

Painted and Anodized

According to ISO 14025
and ISO 21930:2017

OUTPUT FLOWS & WASTE FLOWS								
Hazardous waste disposed (HWD)	kg	4.96E-05	3.15E-08	5.57E+00	--	1.26E-08	3.18E-09	-4.79E-05
Non-hazardous waste disposed (NHWD)	kg	2.84E+03	3.56E-02	7.64E+01	--	1.39E-02	1.00E+02	-3.39E+03
High-level radioactive waste, conditioned, to final repository (HLRW)	kg	8.98E-04	1.28E-06	3.97E-03	--	5.09E-07	3.24E-07	-6.74E-04
Intermediate- and low-level radioactive waste, conditioned, to final repository (ILLRW)	kg	2.32E-02	3.52E-05	1.10E-01	--	1.40E-05	8.63E-06	-1.71E-02
Components for re-use (CRU)	kg	--	--	--	--	--	--	--
Materials for recycling (MFR)	kg	0.00E+00	0.00E+00	3.90E+02	1.07E+03	0.00E+00	0.00E+00	2.67E+00
Materials for energy recovery (MER)	kg	--	--	--	--	--	--	--
Recovered energy exported from the product system (EE)	MJ	--	--	--	--	--	--	--

Table 12. Life cycle impact assessment results per metric ton of thermally treated PAINTED aluminum extrusion products

Impact Category	Unit	A1	A2	A3	C1	C2	C4	D
LIFE CYCLE IMPACTS ASSESSMENT (LCIA) RESULTS								
IPCC, AR5 (IPCC, 2013)								
Global warming potential (GWP 100)	kg CO ₂ eq.	8.57E+03	2.66E+01	4.10E+03	--	1.02E+01	2.20E+00	-8.67E+03
TRACI v2.1 and CML-IA v4.8								
Ozone depletion potential (ODP)	kg CFC 11 eq.	1.66E-06	5.46E-15	9.95E-06	--	2.13E-15	7.35E-15	-2.90E-12
Acidification potential (AP)	kg SO ₂ eq.	3.61E+01	1.19E-01	4.94E+00	--	1.97E-02	9.37E-03	-4.06E+01
Eutrophication potential (EP)	kg N eq.	1.07E+00	1.08E-02	4.02E-01	--	2.83E-03	5.22E-04	-9.00E-01
Smog formation potential (SFP)	kg O ₃ eq.	3.18E+02	2.94E+00	9.65E+01	--	4.46E-01	1.66E-01	-3.34E+02
Abiotic resource depletion potential of non-renewable (fossil) energy resources (ADP _{fossil})	MJ	8.79E+04	3.86E+02	5.64E+04	1.50E+02		3.29E+01	-7.80E+04
RESOURCE USE INDICATORS								
Renewable primary resources used as energy carrier (fuel) (RPR _E)	MJ	4.89E+04	1.56E+01	6.26E+03	--	6.23E+00	2.80E+00	-5.63E+04
Renewable primary resources with energy content used as material (RPR _M)	MJ	0.00E+00	0.00E+00	3.40E-05	--	0.00E+00	0.00E+00	0.00E+00
Non-renewable primary resources used as an energy carrier (fuel) (NRPR _E)	MJ	8.64E+04	3.89E+02	6.16E+04	--	1.51E+02	3.36E+01	-7.94E+04
Non-renewable primary resources with energy content used as material (NRPR _M)	MJ	3.57E+03	0.00E+00	2.60E+03	--	0.00E+00	0.00E+00	0.00E+00

ENVIRONMENTAL PRODUCT DECLARATION



ALUMINUM
EXTRUDERS
COUNCIL

Thermally Improved Aluminum Extrusions

Painted and Anodized

According to ISO 14025
and ISO 21930:2017

Renewable secondary fuels (RSF)	MJ	0.00E+00	0.00E+00	0.00E+00	--	0.00E+00	0.00E+00	0.00E+00
Non-renewable secondary fuels (NRSF)	MJ	0.00E+00	0.00E+00	0.00E+00	--	0.00E+00	0.00E+00	0.00E+00
Recovered energy (RE)	MJ	--	--	--	--	--	--	--
Secondary materials (SM)	kg	9.71E+02	0.00E+00	0.00E+00	--	0.00E+00	0.00E+00	0.00E+00
Use of net fresh water resources (FW)	m ³	1.62E+02	6.67E-02	3.59E+01	--	2.66E-02	4.62E-03	-1.87E+02
OUTPUT FLOWS & WASTE FLOWS								
Hazardous waste disposed (HWD)	kg	5.09E-05	3.17E-08	4.88E-02	--	1.26E-08	3.18E-09	-4.82E-05
Non-hazardous waste disposed (NHWD)	kg	2.88E+03	3.58E-02	4.10E+01	--	1.39E-02	1.00E+02	-3.41E+03
High-level radioactive waste, conditioned, to final repository (HLRW)	kg	9.78E-04	1.29E-06	3.67E-03	--	5.09E-07	3.24E-07	-6.79E-04
Intermediate- and low-level radioactive waste, conditioned, to final repository (ILLRW)	kg	2.53E-02	3.54E-05	1.01E-01	--	1.40E-05	8.63E-06	-1.72E-02
Components for re-use (CRU)	kg	--	--	--	--	--	--	--
Materials for recycling (MFR)	kg	0.00E+00	0.00E+00	3.95E+02	1.08E+03	--	--	2.71E+00
Materials for energy recovery (MER)	kg	--	--	--	--	--	--	--
Recovered energy exported from the product system (EE)	MJ	--	--	--	--	--	--	--

Comparability: Comparisons cannot be made between product-specific or industry average EPDs at the design stage of a project before a building has been specified. Comparisons may be made between product-specific or industry average EPDs at the time of product purchase when product performance and specifications have been established and serve as a functional unit for comparison. Environmental impact results shall be converted to a functional unit basis before any comparison is attempted.

Any comparison of EPDs shall be subject to the requirements of ISO 21930. EPDs are not comparative assertions and are either not comparable or have limited comparability when they have different system boundaries, are based on different product category rules or are missing relevant environmental impacts. Such comparison can be inaccurate and could lead to erroneous selection of materials or products which are higher impact, at least in some impact categories.

When comparing EPDs created using this PCR, variations and deviations are possible. Example of variations: Different LCA software and background LCI datasets may lead to different results for upstream or downstream of the life cycle stages declared.

Per the PCR, industry average EPDs are required to report information on the statistical distribution of results for all the LCIA indicators. The min and max results presented in Table 14 represent the facilities with the lowest (best) and highest (worst) impacts, respectively. It should be noted that, every company did not have all five unite processes (cast house, extrusion, anodizing, painting, thermal treatment). Min and max facilities are calculated for each impact category only for mill-finished extrusions. The mean and median do not take production volumes across facilities into account (i.e. it is a calculation based on each individual facility as a data point), while the weighted average presented in Table 11 to Table 13 are calculated via production volume weightings reported by each participating facility.

ENVIRONMENTAL PRODUCT DECLARATION



ALUMINUM
EXTRUDERS
COUNCIL

Thermally Improved Aluminum Extrusions

Painted and Anodized

According to ISO 14025
and ISO 21930:2017

Table 13 Statistical metrics of LCIA results for 1 metric ton of extruded Aluminum (mill finish) across all facilities

Indicator	Unit	Min (A1-A3)	Max (A1-A3)	Max/Min Ratio (A1-A3)	Mean (A1-A3)	Median (A1-A3)
GWP	kg CO2 eq.	1.47E+03	4.47E+04	3.05E+01	1.25E+04	1.12E+04
ODP	kg CFC 11 eq.	2.21E-10	4.60E-06	2.08E+04	4.85E-07	1.85E-07
AP	kg SO2 eq.	4.25E+00	1.28E+02	3.02E+01	4.58E+01	4.34E+01
EP	kg N eq.	1.55E-01	4.95E+00	3.20E+01	1.26E+00	1.11E+00
SFP	kg O3 eq.	1.11E+03	4.60E+04	4.13E+01	1.17E+04	9.35E+03
ADP _{fossil}	MJ, surplus	6.30E+01	1.16E+03	1.85E+01	4.32E+02	3.93E+02

Visualization Of Life Cycle Impact Assessment

Figures 7 and 8 show the breakdown for life cycle modules for thermally treated anodized and painted Aluminum products.

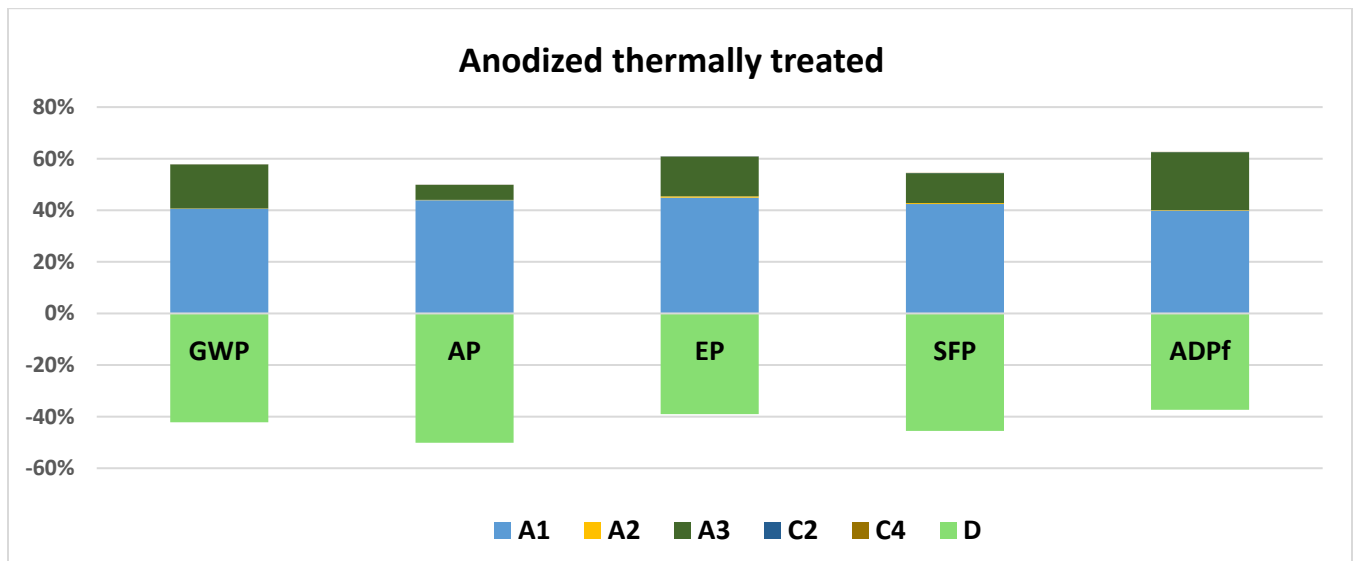

Figure 7: Anodized thermally treated extrusion LCIA results (breakdown per module)

(GWP = Global warming potential (IPCC); AP = Acidification potential; EP = Eutrophication potential; ODP = Stratospheric ozone layer depletion potential (not displayed in the chart due to limited relevance in the foreground of the study); SFP = Smog formation potential; ADPf = Abiotic Depletion Potential, Fossil)

ENVIRONMENTAL PRODUCT DECLARATION



ALUMINUM
EXTRUDERS
COUNCIL

Thermally Improved Aluminum Extrusions

Painted and Anodized

According to ISO 14025
and ISO 21930:2017

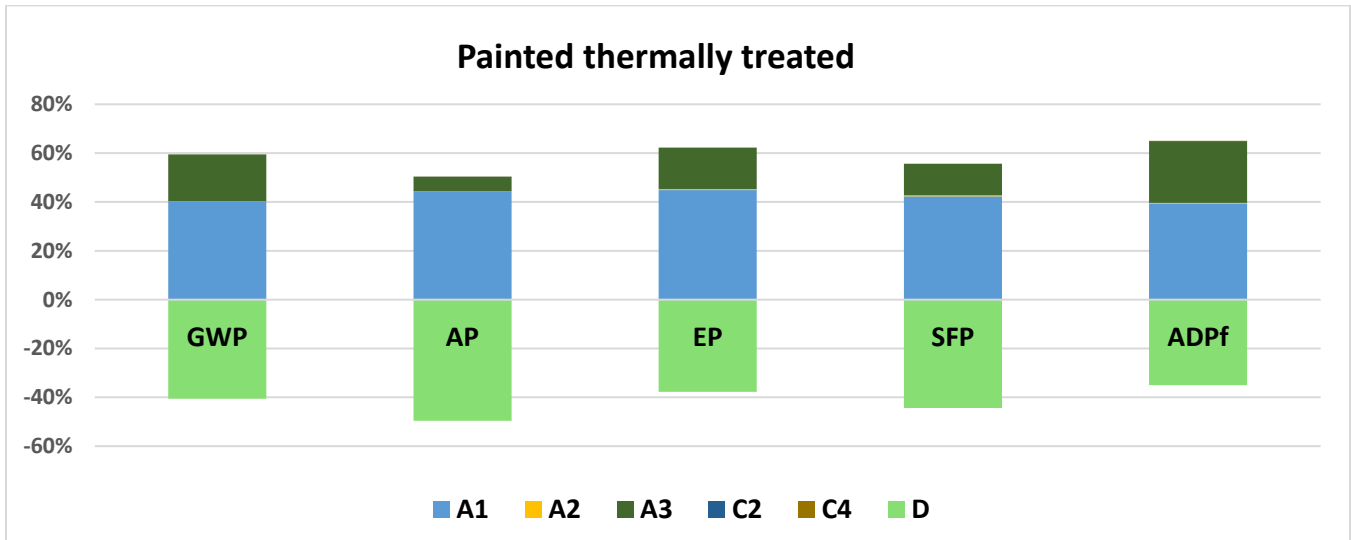

Figure 8: Painted thermally treated extrusion LCIA results (breakdown per module)

(GWP = Global warming potential (IPCC); AP = Acidification potential; EP = Eutrophication potential; ODP = Stratospheric ozone layer depletion potential (not displayed in the chart due to limited relevance in the foreground of the study); SFP = Smog formation potential ; ADPf = Abiotic Depletion Potential, Fossil)

Figure 9 and 10 on the other hand show the contribution by different manufacturing stages so that the effects of different surface treatments and extrusion (and cast house) can be easily visualized.

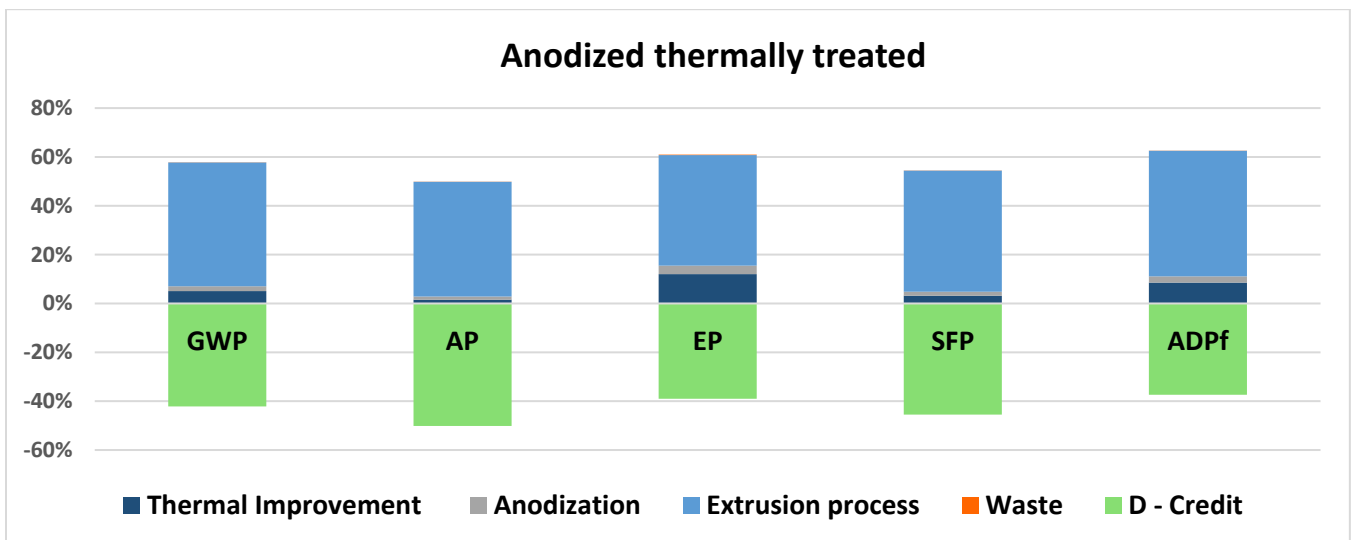

Figure 9: Anodized thermally treated extrusion LCIA results by manufacturing stages

(GWP = Global warming potential (IPCC); AP = Acidification potential; EP = Eutrophication potential; ODP = Stratospheric ozone layer depletion potential (not displayed in the chart due to limited relevance in the foreground of the study); SFP = Smog formation potential ; ADPf = Abiotic Depletion Potential, Fossil)

ENVIRONMENTAL PRODUCT DECLARATION



ALUMINUM
EXTRUDERS
COUNCIL

Thermally Improved Aluminum Extrusions

Painted and Anodized

According to ISO 14025
and ISO 21930:2017

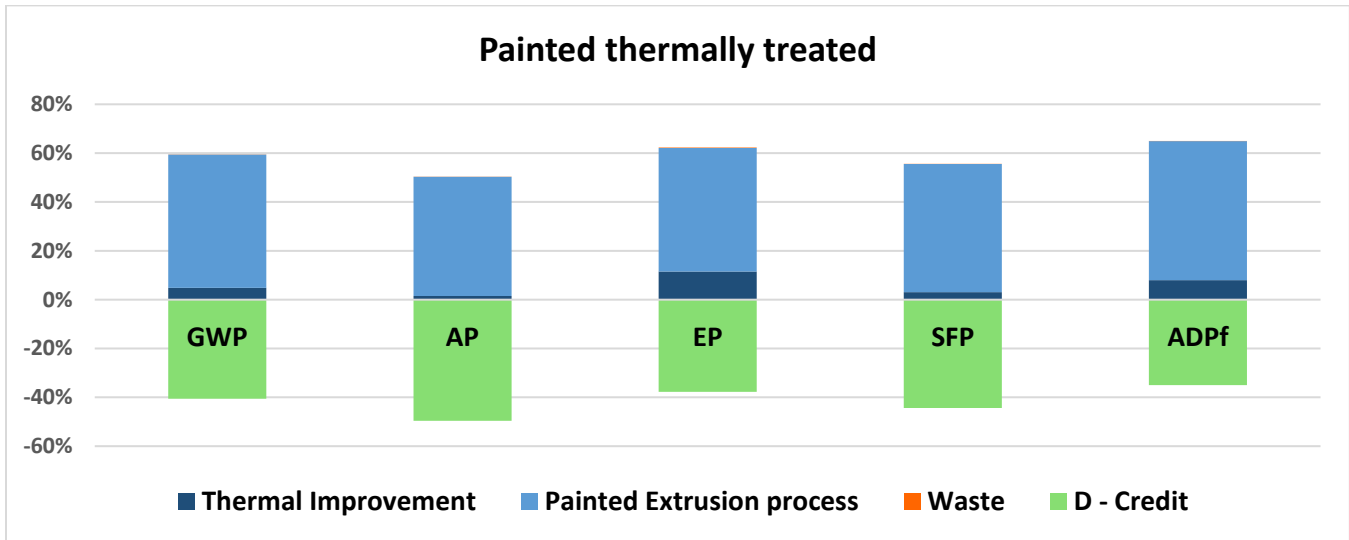

Figure 10: Painted thermally treated extrusion LCIA results by manufacturing stages

(GWP = Global warming potential (IPCC); AP = Acidification potential; EP = Eutrophication potential; ODP = Stratospheric ozone layer depletion potential (not displayed in the chart due to limited relevance in the foreground of the study); SFP = Smog formation potential ; ADPf = Abiotic Depletion Potential, Fossil)

Interpretation

The results represent the cradle-to-gate with options environmental performance of mill finished, painted, and anodized thermally treated aluminum extrusions. As shown in the figures above, the results indicate that the impacts are driven by modules A1 (Raw Material Supply), A3 (Manufacturing) and D (Reuse, recovery, recycling potential). The primary impact is derived from upstream aluminum production and transformation to extrusions in module A1 (raw material supply). The thermal improvement on top of the surface treatment increased the overall GWP slightly.

However, module D (Reuse, recovery, recycling potential) reduces the impact significantly.

As module D (material credit at the end of life) clearly impacts the results, it is important to note that the applied recycling rate of 95% represents a defensible rate for aluminum extrusion products in the building and transportation sectors. This is based on a conservative calculation for global aluminum recycling from these sectors. If a higher rate is used, the credit will increase, thus lowering the total life-cycle impacts. Similarly, a lower recycling rate would raise the total life cycle impacts. As new information becomes available (e.g., the Aluminum Association publishes regional-specific recycling rates), this EPD should be modified to reflect the most current industry conditions (AA, 2022).

Sensitivity Analysis

A sensitivity analysis was conducted to examine the GWP result changes while varying of the primary and secondary aluminum composition of mill finish extrusions. It is to be noted that, all participating companies did not have cast house plant and therefore the total amount of scrap, secondary and primary aluminum coming from cast house was reported as an aggregate rather than a contribution from each individual company. A similar strategy was taken into consideration for extrusion as well to maintain the same model assumption and structure. We varied the recycled content and primary aluminum in the extrusion

ENVIRONMENTAL PRODUCT DECLARATION



ALUMINUM
EXTRUDERS
COUNCIL

Thermally Improved Aluminum Extrusions

Painted and Anodized

According to ISO 14025
and ISO 21930:2017

process maintaining the cast house as is. The results of the sensitivity on the primary and recycled contents in extrusions are shown in Figure 11. Please note that the ratio of primary and recycled content is limited by the amount of recycled content composition in the cast house.

A ten percent increase in primary aluminum in the mill finished product manufacturing will increase the A1-A3 GWP by ~ 1400 kg CO₂eq. This is equal to say that a 10% increase in recycled aluminum content will reduce the carbon footprint by the same amount.

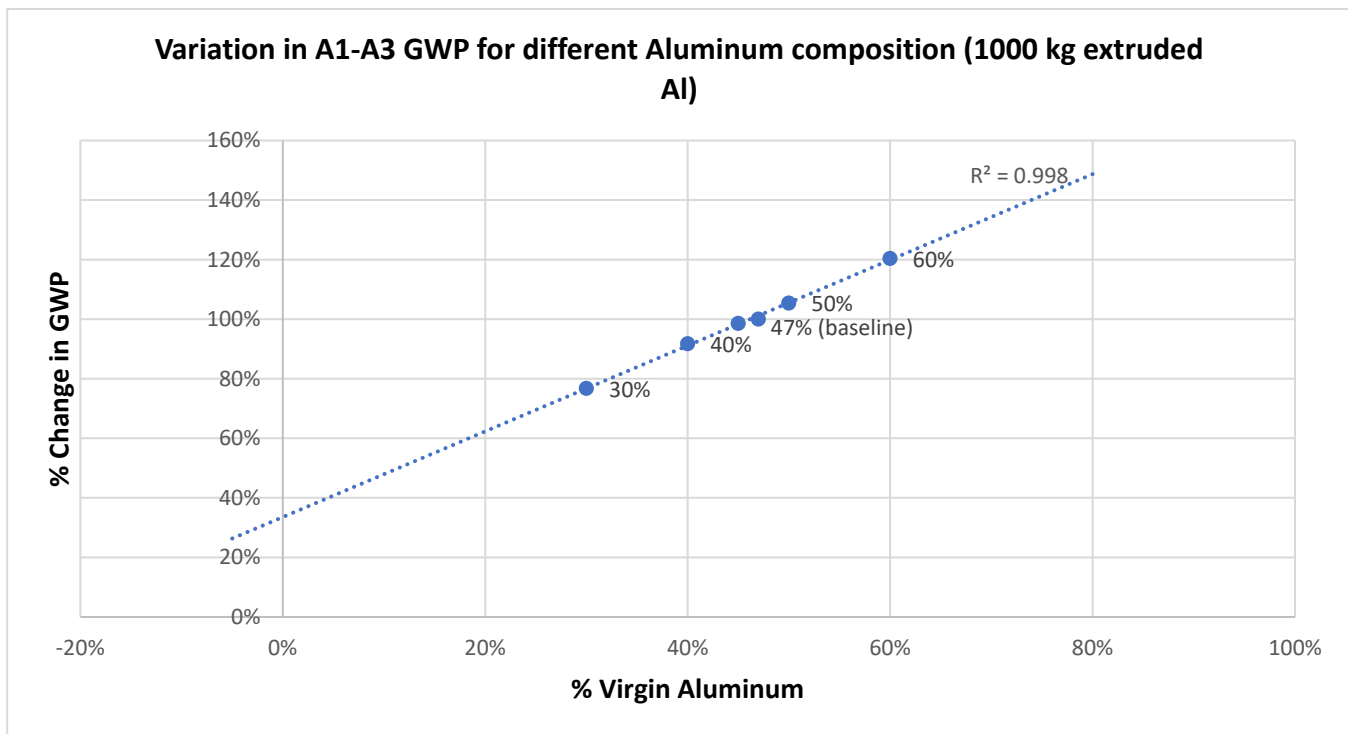

Figure 11 : Sensitivity analysis - impact of primary ingot and recycled content on mill-finished Aluminum extrusions

Scenario Analysis

To see the effect of primary aluminum sourcing, a scenario analysis was conducted to alternate the sourcing from different regions or countries other than the baseline case of the North American consumption mix. The metal compositions – shares of primary and recycled metal in the products, are kept unchanged for the scenario analysis.

Figure -13 shows the GWP changes of primary aluminum sourcing on cradle-to-gate analysis for 1000 kg of extruded

ENVIRONMENTAL PRODUCT DECLARATION



ALUMINUM
EXTRUDERS
COUNCIL

Thermally Improved Aluminum Extrusions

Painted and Anodized

According to ISO 14025
and ISO 21930:2017

Aluminum. The regions and countries included in the scenario analysis are:

- RNA represents the weighted average of primary aluminum consumption mix in North America, which is the baseline case;
- CA represents Canada where primary aluminum is exclusively smelted with hydropower electricity;
- CN represents China where primary aluminum is mainly smelted with coal-fired electricity;
- RME represents the Middle East where primary aluminum is mainly smelted with natural gas fired electricity.

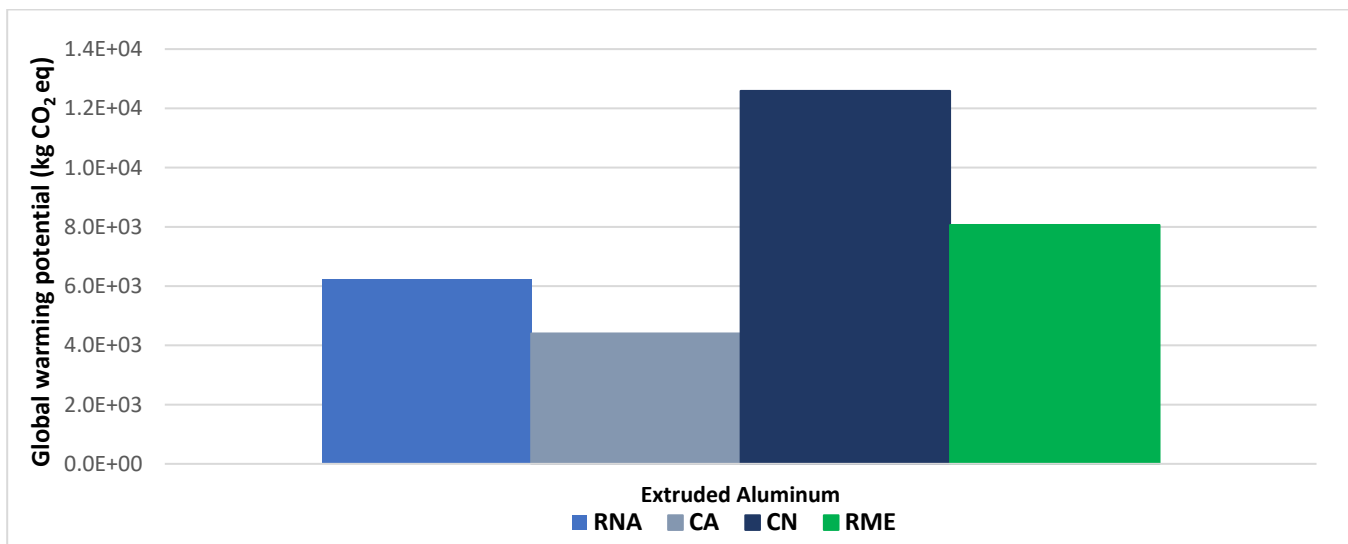

Figure 12 : Effect of source of primary aluminum on cradle-to-gate carbon footprint (RNA: North America, CA: Canada, CN: China, RME: Middle East)

Additional Environmental Information

Environment And Health During Manufacturing

Environmental, occupational health and safety practices are in accordance with OSHA and individual state requirements. The process and the products do not contain any materials or substances for which there exists a route to exposure that leads to humans or flora/fauna in the environment being exposed to said materials or substances at levels exceeding safe health thresholds.

Further Information

Further information can be found at www.aec.org.

ENVIRONMENTAL PRODUCT DECLARATION



ALUMINUM
EXTRUDERS
COUNCIL

Thermally Improved Aluminum Extrusions

Painted and Anodized

According to ISO 14025
and ISO 21930:2017

References

- AA. (2018, August). International Alloy Designations and Chemical Composition Limits for Wrought Aluminum and Wrought Aluminum Alloys. Retrieved from Registration Record Series - Teal Sheets:
<https://www.aluminum.org/sites/default/files/2021-10/Teal%20Sheet.pdf>
- AA. (2022, August). The Aluminum Association. Retrieved from <https://www.aluminum.org/>
- AA. (2022). The Environmental Footprint of Semi-finished Aluminum Products in North America: A Life Cycle Assessment Report. Aluminum Association.
- Bare, J. (2012). Tool for the Reduction and Assessment of Chemical and other Environmental Impacts (TRACI) - Software Name and Version Number: TRACI version 2.1 - User's Manual. Washington, D.C.: U.S. EPA.
- CML. (2016, September 05). CML-IA Characterisation Factors. Retrieved from Universiteit Leiden:
<https://www.universiteitleiden.nl/en/research/research-output/science/cml-ia-characterisation-factors>
- EAA. (2021). <https://www.european-aluminium.eu/>. Retrieved from European Aluminum Website.
- EPA. (2021). Retrieved from <https://www.epa.gov/environmental-topics/chemicals-and-toxics-topics>
- GaBi. (2021). Retrieved from <https://gabi.sphera.com/support/gabi/gabi-lcia-documentation/cml-2001/>
- IPCC. (2006). 2006 IPCC Guidelines for National Greenhouse Gas Inventories - Volume 4 - Agriculture, Forestry and Other Land Use. Geneva, Switzerland: IPCC.
- Sphera. (2020). GaBi energy database, retrieved from Sphera Solutions Inc, <http://www.gabi-software.com/support/gabi/gabi-database-2019-lci-documentation/extension-database-ii-energy/>.
- Sphera. (2020). GaBi LCA Database Documentation. Retrieved from Sphera Solutions, Inc.: <http://www.gabi-software.com/america/support/gabi/>.
- Sphera. (2021). Retrieved from GaBi LCA Database Documentation: <http://www.gabi-software.com/america/support/gabi/>
- Sphera. (2021). GaBi LCA Database Documentation. Retrieved from Sphera Solutions, Inc.: <http://www.gabi-software.com/america/support/gabi/>
- UL. (2018). Part A: PCR Part A for Life Cycle Assessment Calculation Rules and Report Requirements.
- UL. (2022). Part B: Aluminum construction Product EPD Requirements. UL.
- UNEP. (2011). Recycling Rates of Metals : A Status Report. Retrieved from UNE Document Repository:
https://wedocs.unep.org/bitstream/handle/20.500.11822/8702/Recycling_Metals.pdf?sequence=1&isAllowed=y
- White Paper-AEC. (2022). White Paper on Extruded Aluminum in the Built Environment. Aluminum Extruders Council.

ENVIRONMENTAL PRODUCT DECLARATION



Thermally Improved Aluminum Extrusions

Painted and Anodized

According to ISO 14025
and ISO 21930:2017

Contact Information

Study Commissioner



Aluminum Extruders Council (AEC)
1000 N Old Rand Rd. Suite 214
Wauconda, IL 60084
www.aec.org

LCA Practitioner



Sphera Solutions, Inc.
130 E Randolph St, #2900
Chicago, IL 60601
<https://sphera.com/contact-us/>
www.sphera.com